

#29

**Raptor-4G**  
By AirDog®

**RP-4G-100  
&  
RP-4G-150**

# INSTALLATION MANUAL

FOR 6.5L POWERED

## CHEVY & GMC TRUCKS

1992-2000

HIGH PERFORMANCE FUEL SYSTEM  
WITH QUICK CONNECT COMPONENTS

PLEASE READ THESE INSTRUCTIONS THOROUGHLY  
BEFORE BEGINNING THE INSTALLATION

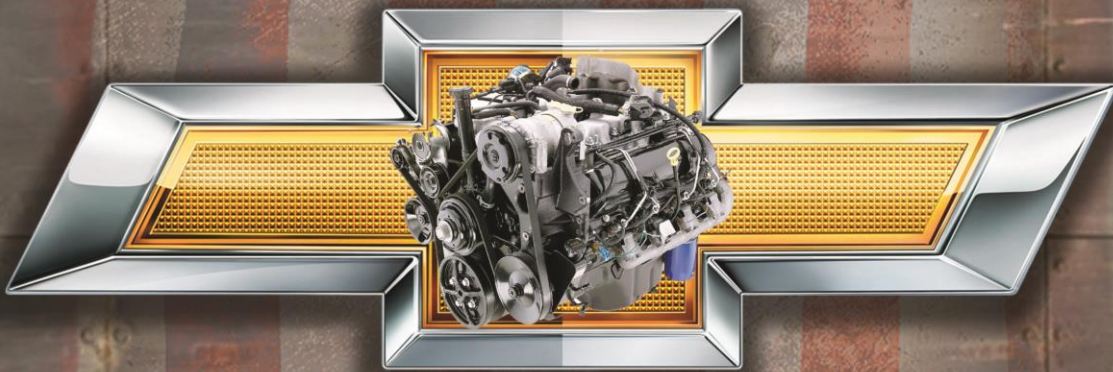

**PUREFLOW AIRDOG**  
705 W MAUSOLEUM RD.  
SHELBYVILLE, IN 46176

877-421-3187  
PUREFLOWAIRDOG.COM

PROTECTED BY

CANADIAN PATENT  
2,108,391

US PATENTS  
5,355,860; 5,746,184; 6,729,310

AUSTRALIAN PATENT  
2005101054

NEW ZEALAND PATENT  
532356

Additional Foreign Patents Pending in Europe, South America, Mexico, Japan, and China!

# Raptor-4G By AirDog®



**THE FITTINGS THAT ARE INCLUDED ARE FOR INSIDE FRAME RAIL MOUNTING**

## OVERVIEW

Thank you for your purchase and welcome to PureFlow AirDog's **Raptor-4G** fuel lift pump for the 1992-2000 6.5L Chevy diesel engine.

The Raptor-4G is a premium fuel pump that incorporates PureFlow AirDog's 4G quiet and smooth running four bearing design. This fuel system requires no return line as the fuel is internally regulated. The fuel is delivered to the engine at the correct pressure and flow rate to meet the demands of the engine under all operating conditions.

Pressure and flows are approximate as they will vary with fuel temperature and as the brushes wear in. The pressure will also vary per application through variation of vehicle voltage/amp output and fuel line installation. **It is recommended to install a fuel pressure gauge before the truck is started for the first time to verify fuel pressure.**

The Raptor-4G systems feature a built in adjustable pressure regulator. All Raptor-4G systems include a complete installation kit.

The Raptor-4G for this particular application is preset at 8-10psi from factory for a stock application. The regulator is adjustable up to 75psi for fine tuning the system for performance upgrades. **WARNING: RUNNING THE PUMP ABOVE 75PSI WILL DECREASE THE LIFE OF THE PUMP SIGNIFICANTLY AND MAY VOID THE WARRANTY. BECAUSE YOU CAN TURN UP THE FUEL PRESSURE DOESN'T MEAN YOU SHOULD. MORE PRESSURE DOES NOT MEAN MORE FLOW. MORE PRESSURE MEANS LESS FLOW. YOU SHOULD SET FUEL PRESSURE PER PERFORMANCE UPGRADE RECOMMENDATIONS.**

PureFlow AirDog® products are manufactured in Shelbyville Indiana by a team of skilled workers with unsurpassed attention to detail and using the most stringent quality assurance.

### TYPICAL CHEVY INSTALLATION LAYOUT:

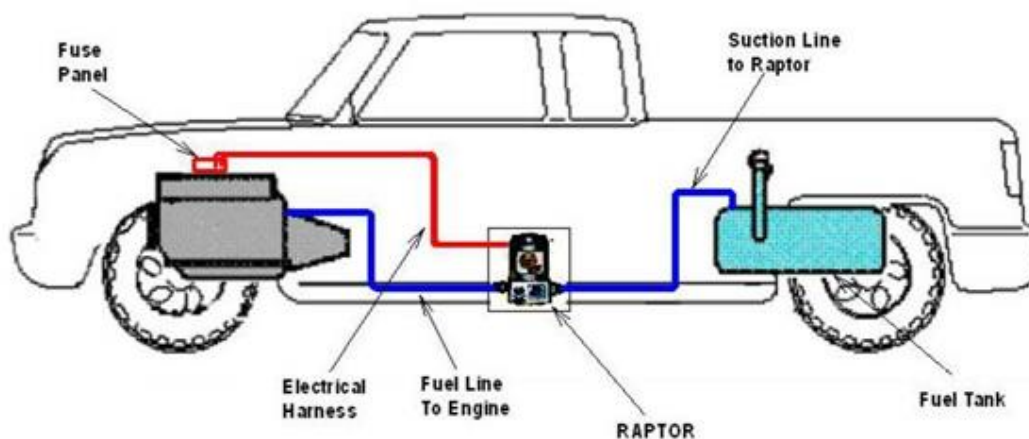

**NOTE:** The pictures used in this manual are for example only and may not be exactly the same as your truck.

## **!STEPS TO TAKE BEFORE INSTALLATION!**

1. **Inventory the package components completely.** Notify PureFlow AirDog® immediately of any parts missing or damaged. (877-421-3187)
2. Read the installation manual and understand how the system operates before beginning installation
3. The installation recommendations contained herein are suggested installation guidelines only. Individual installations may vary.
4. If any installation procedure is uncertain, contact PureFlow AirDog® for technical assistance. (877-421-3187)

## **QUICK CONNECT COMPONENT OVERVIEW**

Provided in this kit is an OE style quick connection system. This system allows a quick, clean, and professional install.

### **SAE J2044 Quick Connect System**

The SAE J2044 quick connect system is the most commonly used system in the automotive industry. The images below show the formation of SAE J2044 connection. To connect the assemblies, simply insert the male end form into the mating female connector. Push firmly until you hear it “click” into place. To disconnect the fittings, press down and hold the tabs on the female connector while you firmly pull the assembly apart.



## TABLE OF CONTENTS

<b>SECTION</b>	<b>DESCRIPTION</b>	<b>PAGE</b>
1	OVERVIEW	3
2	TABLE OF CONTENTS	5
3	SAFETY GUIDELINES	6
4	PARTS LIST	7
5	SYSTEM ILLUSTRATION	8
6	PUMP FITTING INSTALLATION	9
7	MOUNTING THE RAPTOR-4G	10
8	FUEL LINE ASSEMBLY	12
9	SUPPLY LINE TO THE ENGINE	13
10	SUCTION LINE FROM THE FUEL TANK	15
11	WIRING HARNESS INSTALLATION	16
12	INITIAL START PROCEDURE	18
13	ADJUSTING THE FUEL PRESSURE	19
14	SERVICE AND TROUBLESHOOTING	20
15	LIMITED LIFETIME WARRANTY	23

**!SAFETY GUIDELINES!**

- CAUTION!** Please be sure to chock the vehicle's tires to prevent rolling.
- CAUTION!** Please use proper supports when working beneath an elevated vehicle.
- CAUTION!** Most diesel pickups have two (2) 12volt batteries. Disconnect the battery cables to both batteries before proceeding with the Raptor-4G® installation.
- CAUTION!** Vehicle frame rails should not be drilled into or welded upon.
- CAUTION!** Wear safety glasses when operating power tools such as drills and grinders or when using a punch or chisel.
- CAUTION!** Use common sense when routing fuel lines and electrical harnesses. Keep them away from hot exhaust components and/or moving parts. Properly secure lines to prevent chaffing.

Use Good Judgment and Common Sense When Installing the Raptor-4G!

**RAPTOR-4G PARTS LIST****(VERIFY YOU HAVE ALL THE CORRECT PARTS BEFORE BEGINNING THE INSTALLATION!)**

<b>QTY</b>	<b>DESCRIPTION</b>	<b>PART NUMBER</b>	<b>IMAGE</b>
1	RAPTOR-4G FUEL PUMP	RP-4G-100 OR RP-4G-150	
1	WIRING HARNESS	5E-2-012	
1	FRAME BRACKET SET	010-3C-0002 010-3C-0001	
1	SPACER	010-3C-0003-A-P	
1	CABLE TIE BUNDLE	5H-2-1-06/12	
1	HARDWARE KIT	901-61-0102-PM- RP-C	
1	14FT FUEL LINE	HS14	
2	1/2" FEMALE QUICK CONNECT TO 1/2" BARBED MALE FITTING	FQC12S	
2	3/8" COMPRESSION X 3/8" NPT MALE	4A-1-07-06-06-B	
2	3/8" NPT FEMALE X -8 JIC MALE	4A-2-02-06-08-B	
2	1/2" PUSH TO LOCK X -8 JIC SWIVEL FEMALE	4A-1-09-08-08-B	
1	1/2" MALE QUICK CONNECT TO 3/4-16 ORB ("IN" FITTING)	08J2044-3/4UNF	
1	1/2" MALE QUICK CONNECT TO 9/16-18 ORB ("OUT" FITTING)	08J2044916UNF	
1	MALE SPADE CONNECTOR	5D-1-08-A-16/14	
1	SERVICE O-RING KIT	901-05-0102	

**SYSTEM ILLUSTRATION**  
(VIEW FROM INSIDE THE FRAME RAIL)

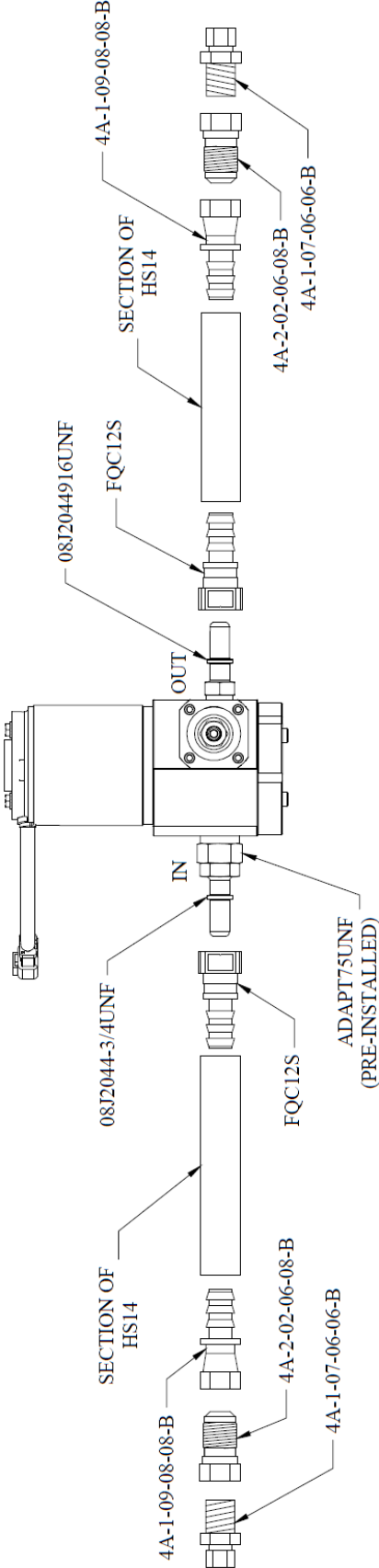



## PUMP FITTING INSTALLATION

### ITEMS NEEDED:

1. 08J2044-3/4UNF FITTING
2. 08J2044916UNF FITTING
3. TORQUE WRENCH
4. DEEP 3/4" SOCKET
5. DEEP 7/8" SOCKET

**WARNING:** Do not overtighten the aluminum fittings or they may break! Torque specs are listed in red below. Broken fittings from mis-installation are not a warrantable item.

- 6-1. Install the 08J2044-3/4UNF fitting into the "IN" side of the fuel pump by, first, hand threading the fitting into the screen adapter. Then take the torque wrench with a 7/8" deep socket attached and **torque the fitting to 180in-lb or 15ft-lb**. Refer to figure 1 and 2.



Figure 1



Figure 2

- 6-2. Next, install the 08J2044916UNF fitting in the "OUT" port of the pump by, first, hand-threading the fitting in. Then, take the torque wrench with a 3/4" deep socket attached and **torque the fitting to 120in-lb or 10ft-lb**. Refer to figures 3 and 4.



Figure 3



Figure 4

## MOUNTING THE RAPTOR-4G TO THE FRAME

### ITEMS NEEDED:

1. 010-3C-0001 BRACKET
2. 010-3C-0002 BRACKET
3. 010-3C-0003-A-P SPACER
4. 5/16-18X.75 OR X 2.75 FLAT CAP SCREWS X4
5. 3/8-16X4.5" BOLT, 3/8-16 NUT, 3/8 SPLIT LOCK WASHER X3ea.
6. 3/16" ALLEN WRENCH
7. 9/16" WRECH OR SOCKET WRENCH

**NOTE:** It is highly recommended to mount the Raptor-4G to the inside of the frame rail as high as possible to protect it from road debris. The "IN" side of the pump is to face towards the tank.

**NOTE:** It is highly recommended to mount the pump vertically as pictured in this section.

**NOTE:** The spacer block is included to clear any fuel or brake lines along the frame. It is not required to be used. There are two different length 5/16-18 cap screws in the case the spacer is not used.

## Section 7 (Continued)

## MOUNTING THE RAPTOR-4G

- 7-1. Hold the 010-3C-0001 bracket and Raptor-4G up to the frame where it is desired to be mounted to figure out which set of holes to use in the plate. Take note of which holes to use.
- 7-2. If the spacer block is to be used (010-3C-0003-A-P), sandwich it between the Raptor-4G and the 010-3C-0001 and use the 5/16-18x2.75 cap screws using the holes noted above in step 7-1. Use the 3/16" Allen wrench to tighten the bolts. Refer to figures 5 and 6.



Figure 5

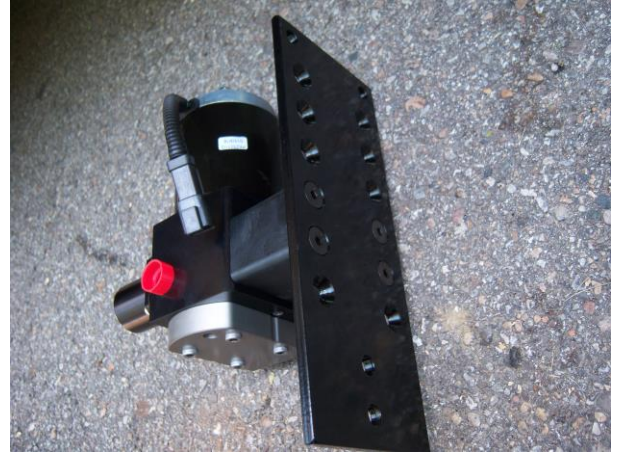

Figure 6

- 7-3. Mount the Raptor-4G onto the frame rail using the assembly from the previous step, the back plate (010-3C-0002), and the mounting hardware (3/8-16x4.5" bolts, 3/8-16 nuts, 3/8 split lock washers). **Tighten the 3/8 bolts with the 9/16" wrenches until the split lock washers are flat. Overtightening may result in bent brackets or chipped powder coat.** Refer to figure 7.



Figure 7

## ASSEMBLING THE FUEL LINES

**This kit includes a length of fuel line and separate fuel line fittings to allow for much cleaner looking installations! Assemble the fuel lines as you install them. You won't want to pre-assemble the hoses or your lengths may be off.**

**NOTE:** Hose clamps are not needed for these push-lock connectors. Hose clamps may cut the fuel line and cause leaks.

- 8-1. Take the fuel line end and lubricate the barbed end with clean motor oil (Figure 8) and press it into the fuel line (HS14) until all three barbs are covered (Figures 9 and 10). The fuel line end should look like Figure 10 when properly pressed in.



Figure 8



Figure 9



Figure 10

- 8-2. Now plug that fuel line with that fitting into the connection on the either the Raptor or the truck where the manual calls it out.
- 8-3. Run the fuel line along the frame away from any hot or moving parts such as exhaust or the driveshaft (Figure 11). Cut the hose to length and insert the other fuel line end that the manual calls out into the fuel line as outlined in step 8-1.



Figure 11

## SUPPLY LINE GOING TO ENGINE

### ITEMS NEEDED

1. 4A-1-07-06-06-B
2. 4A-2-02-06-08-B
3. 4A-1-09-08-08-B
4. HS14 FUEL LINE

- 9-1. Remove the factory electric fuel Pump (Figure 12) mounted on the driver's side frame rail.

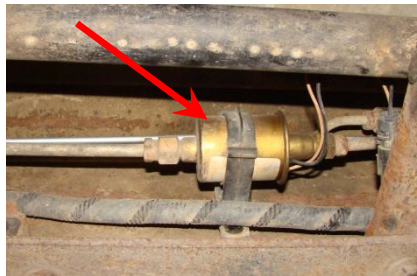

Figure 12

- 9-2. Assemble the compression fitting (P/N 4A-1-07-06-06-B) to the -8 JIC flare fitting (P/N 4A-2-02-06-08-B). Thread sealant is recommended. Refer to figure 13.
- 9-3. Cut the steel fuel line that goes to the engine and install the compression side of the previously assembled fitting onto it (Figure 14)



Figure 13



Figure 14

- 9-4. Install the straight -8 swivel to 1/2" Push Lock fitting (P/N 4A-1-09-08-08-B) on one end of the fuel line (HS14). To do so, lubricate the barbed end of the swivel fitting with clean motor oil and press it into an open end of the 14ft fuel line (HS14). Refer to figures 15 and 16. This process is similar to section 5.



Figure 15



Figure 16

- 9-5. Thread the swivel end that is now pressed into the fuel line on the fitting installed in step 9-3. Tighten the fitting till snug with a 7/8" wrench. Do not overtighten!

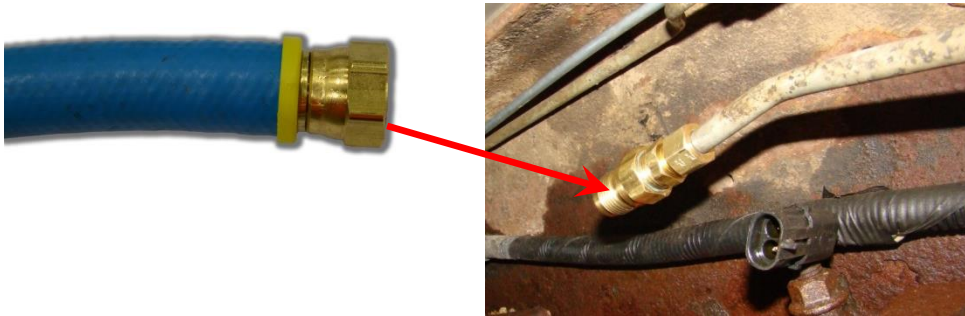

Figure 17

- 9-6. Run the fuel line along the frame as mentioned in step 8-3 to the "OUT" port in the Raptor-4G. Cut the fuel line to length and insert fuel line end FQC12S per step 8-1. Once the connector is installed, connect it to the male J2044 fitting in the "OUT" port in the Raptor-4G. A "click" will be heard once properly connected.

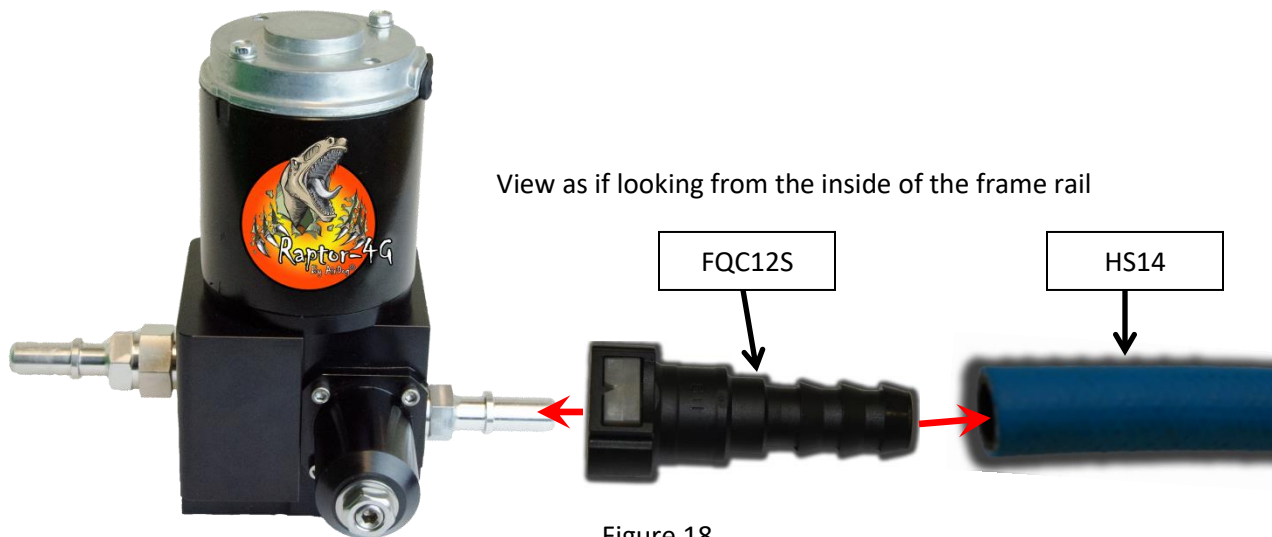

Figure 18

- 9-5. Once the fuel line is routed and connected, you may use the cable ties (5H-1-2-06/12) to securely fasten the fuel line to the frame. Remember to keep it away from any hot or moving parts such as exhaust piping and driveshafts.

## SUCTION LINE FROM THE TANK TO THE RAPTOR-4G

### ITEMS NEEDED:

1. 4A-1-07-06-06-B
2. 4A-2-02-06-08-B
3. 4A-1-09-08-08-B
4. HS14 FUEL LINE

- 10-1. Cut the steel fuel line that comes from the tank. Assemble a 3/8" compression fitting to the 3/8" NPT female to male -8 JIC (same as step 9-2 and 9-3). Install the compression end of that fitting assembly to the fuel line.

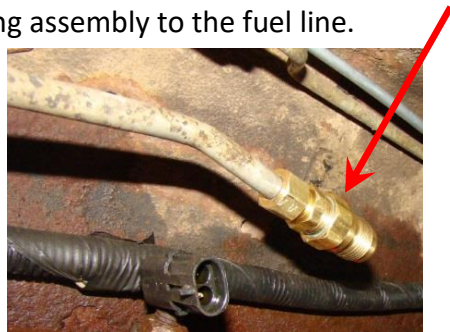

Figure 19

- 10-2. Repeat steps 9-4 and 9-5 to install the swivel end on the fitting assembly previously installed in step 10-1. Again, do not overtighten the fitting!
- 10-3. Run the fuel line along the frame as mentioned in step 8-3 to the Raptor-4G "IN" port. Cut the fuel line to length and insert fuel line connector FQC12S per step 8-1. Once the fuel line end is pressed in, connect it to the male J2044 fitting in the Raptor® "In" port. A "click" will be heard once properly connected.

View as if looking from the inside of the frame rail

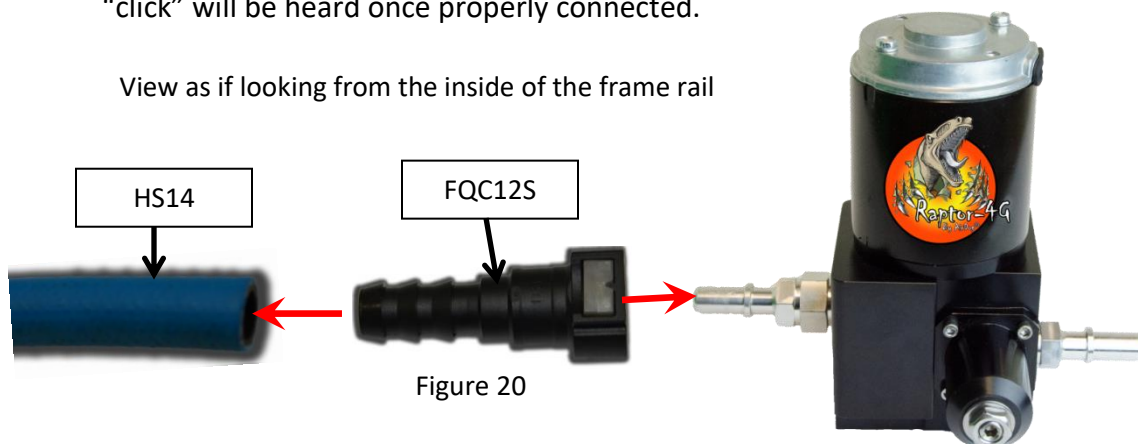

Figure 20

- 10-4. Once the fuel line is routed and connected, you may use the cable ties (5H-1-2-06/12) to securely fasten the fuel line to the frame. Remember to keep it away from any hot or moving parts such as exhaust piping and driveshafts.

## WIRING HARNESS ROUTING AND INSTALLATION

### ITEMS NEEDED:

1. 5E-2-012 WIRING HARNESS
2. WIRE CRIMPS
3. WIRE STRIPPERS

### WIRING DIAGRAM

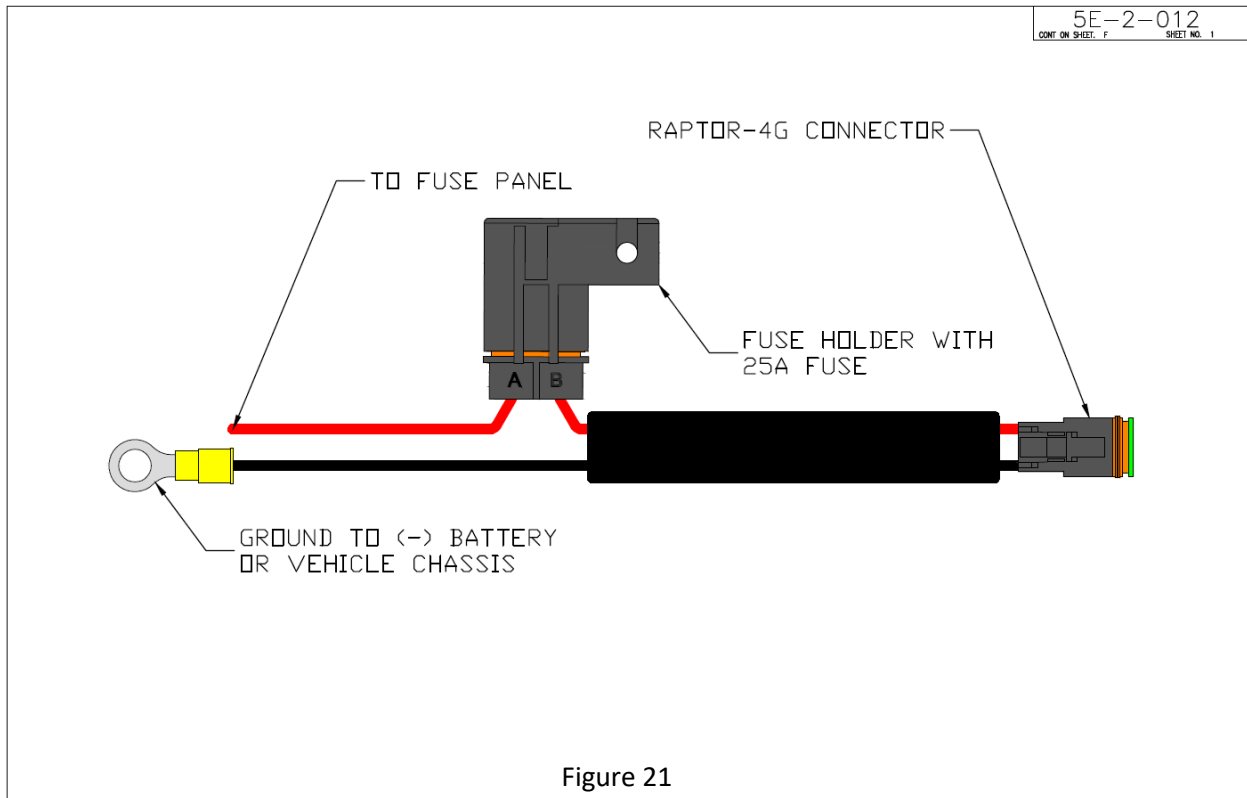

- 11-1. Attach the ground eyelet to either a battery (-), Alternator (-), or the vehicle chassis.

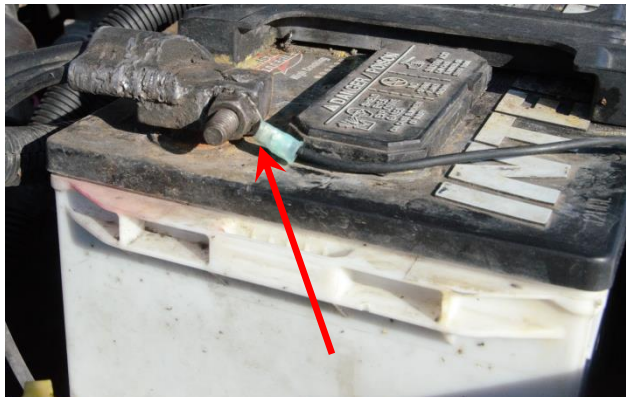

Figure 22



- 11-2. Run the red positive wire to the fusebox and find a key on hot source to tap into.
- 11-3. Cut the positive wire to length and strip the wire sheath back about ¼" exposing the wire, then crimp on the 5D-1-08-A-16/14 male spade connector.



Figure 23

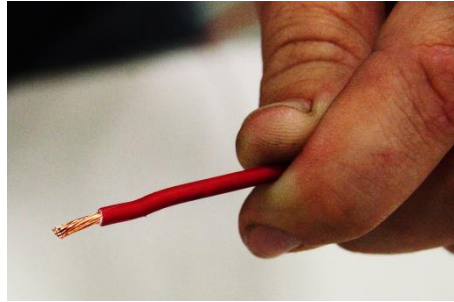

Figure 24

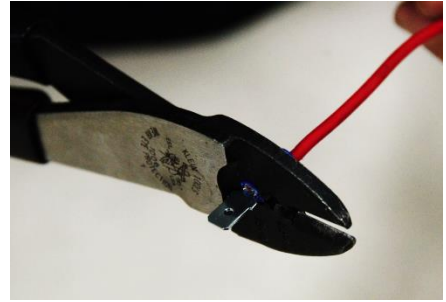

Figure 25

- 11-4. Plug the spade connector into the previously found hot, key on, power source.
- 11-5. Run the Raptor-4G power supply lead down along the frame and plug it into the Raptor-4G until an audible click is heard.



Figure 26

- 11-6. Secure the wiring to the frame with the cable ties provided. Remember to keep the wiring away from any hot or moving parts such as exhaust or driveshafts.

## INITIAL START PROCEDURE

- 12-1. The Raptor-4G is a self-priming system.
- 12-2. Before the truck is started it is recommended to check fuel pressure at the pump. To check fuel pressure before the truck is started, refer to section 13.
- 12-3. Turn the starter key to the on/run position.
- 12-4. Listen for a change of tone. A change of tone means the pump is primed and the engine is ready to start.
- 12-5. Start engine.
- 12-6. **RECHECK ALL FUEL FITTINGS FOR LEAKAGE AND PROPERLY TORQUE. BE SURE ALL FUEL LINES ARE PROPERLY ROUTED TO PROTECT FROM EXCESSIVE HEAT AND SECURED TO PROTECT FROM CHAFFING AND ABRASION. RECHECK ALL ELECTRICAL LINES, SECURE AS NECESSARY.**
- 12-7. **Be sure to fill out the supplied warranty card and mail it in within 30 days of purchase with a copy of either the receipt or packing slip to be registered for the limited lifetime warranty. Failure to do so, and the pump will carry a 1 year warranty only. For a description of the warranty, refer to section 15.**

**PureFlow / AirDog**

**WARRANTY REGISTRATION CARD**

SERIAL NO.: \_\_\_\_\_

MODEL: \_\_\_\_\_

DATE PURCHASED: Month \_\_\_\_\_ Day \_\_\_\_\_ Year \_\_\_\_\_

QUALITY OF THE PRODUCT:  Excellent  Good  Fair  Poor

COMMENTS:

\_\_\_\_\_  
 \_\_\_\_\_  
 \_\_\_\_\_

NAME OF PURCHASER: \_\_\_\_\_

MAILING ADDRESS: \_\_\_\_\_

CITY \_\_\_\_\_ STATE \_\_\_\_\_ ZIP \_\_\_\_\_

PHONE: (\_\_\_\_) \_\_\_\_\_ - \_\_\_\_\_ FAX: (\_\_\_\_) \_\_\_\_\_ - \_\_\_\_\_

EMAIL: \_\_\_\_\_

PURCHASED FROM: \_\_\_\_\_

I have read and have a copy of my Limited Express Warranty covering my purchase.

Signed: \_\_\_\_\_ Date: \_\_\_\_\_

Please complete all required information and include a copy of your sales receipt. Fold at indicated marks and tape. Apply proper postage and return to PureFlow AirDog within thirty (30) days of purchase to activate your Lifetime Limited Express Warranty.

**FAILURE TO PROPERLY TURN IN YOUR LIFETIME WARRANTY REGISTRATION CARD WILL AUTOMATICALLY RESULT IN A ONE (1) YEAR WARRANTY!**

AG2000 REV 6 12/20/01

Figure 27

## ADJUSTING FUEL PRESSURE

- 13-1. Install a 1/8npt center back fuel pressure gauge in the pump or anywhere between the Raptor-4G and the injection pump. There are two 1/8npt ports on the raptor (Figure 27). The pressure port is the one on the right as pictured in figure 28. The left port will not read fuel pressure as it is the suction side of the pump. You will need a 3/16" allen to remove the pipe plug. Another option is an inline fuel pressure tee. Diesel Rx sells fuel pressure tees that will splice right into the Raptor-4G 1/2" fuel line. The part number for the Tee is 001-4A-1-0027-P and is pictured in figure 29.

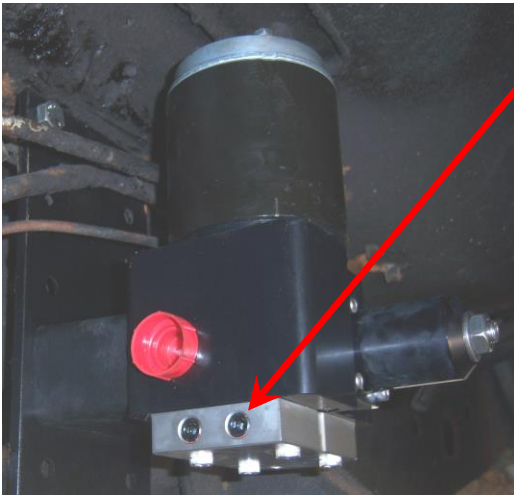

Figure 27



Figure 28



Figure 29

- 13-2. Once a fuel pressure gauge is installed, turn the key on so that the pump is running.
- 13-2. Loosen the jam nut with a 5/8 wrench and adjust the pressure using a 3/16" allen wrench. Clockwise for more pressure and Counter-Clockwise for less pressure. Once the correct pressure is achieved (8-10 psi for this application) start the engine.
- 13-3. With the engine running, verify the pressure remains correct. Make any adjustments at this time, if needed. Once satisfied with the fuel pressure, tighten the jam nut back up to lock in the pressure.

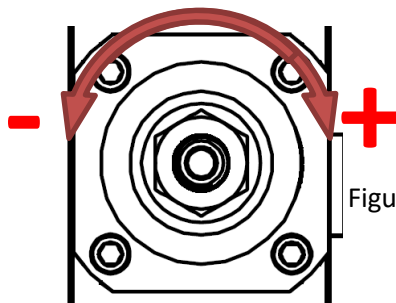

Figure 30

## SERVICE AND TROUBLESHOOTING

In the unlikely event that there is an issue with pump performance, here are some steps to follow. If you have gone through these steps and you are still experiencing an issue, gather your serial number off of the silver plate on the pump and call into tech support at (877)-421-3187 and speak to a technician.

### NOISY PUMP:

A noisy pump is most likely associated with a restriction or aeration in the suction side of the pump. Some troubleshooting steps are as follows:

1. Check the fuel line for any cracks or damage. Cracked or damaged fuel lines will pull in air and affect pump performance and cause the pump to run loudly. Replace any cracked or worn fuel lines.
2. Check for any leaking fittings. Leaking fittings may also cause a suction leak. Properly torque any leaking fittings.
3. Check for an inlet restriction. The Raptor-4G is equipped with an inlet screen to keep particles from jamming the pump. Remove the inlet fitting and inlet screen adaptor to check for debris. Blow out debris and reinstall inlet screen adaptor and inlet fitting. **DO NOT RUN THE PUMP WITHOUT THE INLET SCREEN!**
4. If the previous steps fail to quiet down the pump, perform a bucket test to eliminate issues at the tank. To perform a bucket test, remove the suction line from the fuel tank, put it in a bucket of fuel, and run the pump. If the noise goes away, the issue is within the fuel tank or at the fuel tank connection. If the noise does not go away, get your serial number off the pump and call tech support at (877) 421-3187.

### EXCESSIVE FUEL PRESSURE DROP UNDER ACCELERATION:

A pressure drop of a couple psi is to be expected. Excessive fuel pressure drops under acceleration can be associated with an inlet restriction and/or suction leaks as well. Run through steps 1-3 in the "NOISY PUMP" section. If pump pressure still drops excessively, get the serial number off the pump and call into tech support at (877) 421-3187.

## PUMP LEAKS FUEL:

The Raptor-4G is equipped with O-ring boss style fittings that use an O-ring to seal the fittings to the pump. Here are some steps to follow in case the pump leaks fuel:

1. Verify the fittings are properly torqued per section 6 in this manual. If fittings are loose, properly torque them.
2. Clamp off the fuel lines to prevent fuel loss and remove the “tombstone” cap from the bottom of the pump by removing the four 3/16 allen head cap screws. Inspect the O-rings for any damage. Replace any damaged O-rings with ones from the O-ring service kit that came with this pump. Be sure the O-rings are completely seated in the grooves, or damage to the O-rings may occur when re-installing the cap.
3. If fuel appears to be leaking between the mounting plate and the pump or the previous steps did not cure the issue, get the serial number off the pump and call the tech department at (877) 421-3187.

## PUMP DOES NOT RUN:

A no pumping situation can be associated with either an electrical or mechanical issue. Here are some steps to run through to identify the issue:

1. Inspect the inline fuse. If the fuse is blown, replace the fuse. If the fuse blows immediately, go to the next step.
2. A fuse that blows immediately indicates a possible jam in the Gerotor. To inspect the Gerotor, remove the four 3/16” allen head cap screws from the bottom of the pump and remove the “tombstone” cap and remove the gears. The gears may fall out, so be take care when removing. If the gears do not fall out, use a magnet to remove the gears.
3. With the gears out, replace the fuse and key on the truck to turn on the pump. If the pump still blows the fuse, call into tech support with your serial number (877) 421-3187. If the fuse does not blow, continue to the next step.
4. Spin the removed gears in your hand to verify free movement. If the inner gear does not move within the outer gear, separate the two and clean out any debris present. Once the gears are clear of debris, lubricate them with clean motor oil, reinstall them, be sure the O-rings from the cap are in the correct place in the grooves, and reinstall the cap using the previously removed cap screws.
5. After re-installing the gears and the fuse still blows, get your serial number and call tech support (877) 421-3187.

**NO SUCTION:**

1. Verify the pump is running. If the pump is not running, refer to the “Pump Does Not Run” section.
2. If the pump runs, clamp off the suction line to keep fuel spillage minimal and disconnect it from the pump. With the pump running, feel for suction at the pump fitting. If suction is felt, there is an issue with the suction line or tank pulling in air and continue on to step 3. If weak or no suction is felt at the pump, inspect the inlet screen for debris. Excessive debris in the screen will cause low suction. Clean the inlet screen by removing the inlet screen adapter and blowing it out. Reinstall and check for better suction. If suction is better, reinstall the fuel line. If suction is not better, continue to step 4.
3. Inspect the fuel line for any cracks and replace if necessary. If the suction line looks fine, perform a bucket test as described in step 4 of the “Noisy Pump” section. If the pump picks up fuel at that point, the issue is internal to the fuel tank suction tube.
4. If suction is still weak, get the serial number off of the pump and call into tech support at (877) 421-3187.

**NO PRESSURE:**

1. Verify the pump has suction by running through the “No suction section.”
2. If the pump has suction, verify the fuel pressure by installing a fuel pressure gauge as described in section 15.
3. If the pump pressure is too low, adjust the fuel pressure as described in section 15 to 8-10psi.
4. If the pump performance does not improve and the previous check have been verified, get the serial number off of the pump and call into tech support at (877) 421-3187.

PUREFLOW AIRDOG  
***LIFETIME LIMITED EXPRESS WARRANTY***

**IMPORTANT NOTICE**

**TO ACTIVATE YOUR PUREFLOW AIRDOG WARRANTY, YOU MUST COMPLETE AND MAIL YOUR WARRANTY CARD TO PUREFLOW AIRDOG WITH A COPY OF YOUR ORIGINAL SALES RECEIPT WITHIN 30 DAYS OF PURCHASE. FAILURE TO COMPLETE AND SUBMIT YOUR WARRANTY CARD WILL RESULT IN A WARRANTY PERIOD OF THE COVERED PRODUCE TO ONE (1) YEAR FROM THE DATE OF PURCHASE.**

PureFlow AirDog (hereafter collectively, "SELLER") warrants and guarantees only to the Original Purchaser (hereafter collectively, BUYER) that All PureFlow AirDog Systems (hereafter collectively, PRODUCT) shall be free from defects of materials and workmanship in the manufacturing process for as long as the BUYER owns the PRODUCT.

The Lifetime Limited Express Warranty is limited to the PRODUCT purchased by the original BUYER of the PRODUCT and limited solely to the parts contained within the PRODUCT and EXCLUDES ALL ELSE INCLUDING FILTERS AND WATER SEPARATORS. Any PRODUCT that is in question of Warranty must be returned, shipped prepaid, to PureFlow AirDog. All Warranty claims are subject to the approval of PureFlow AirDog. If it is determined that a Warranty claim exists, PureFlow AirDog will, at its sole discretion, replace the defective PRODUCT with a comparable PRODUCT, repair the defective PRODUCT, or refund the BUYER'S purchase price in exchange for the PRODUCT. Repairs or replacements are warranted for only the remainder of the original warranty period and only to the original BUYER.

Under no circumstances shall the SELLER be liable for any labor charged or travel time incurred in the diagnosis for defects, removal, or reinstallation of the PRODUCT, or any contingent expense.

Under no circumstances will the SELLER be liable for any damage or expense incurred by reason of the use or sale of the PRODUCT.

Other than expressly set forth herein, the SELLER shall in no way be responsible for the proper or improper use and service of the PRODUCT. In no event shall the SELLER be liable for any special, incidental, indirect or consequential damages of any kind or nature, whether or not the BUYER of the PRODUCT was advised of the possibility of damage or harm, arising or resulting from the use or performance of the PRODUCT and BUYER hereby waives the right to any and all such claims.

BUYER, acknowledges that he/she is not relying on SELLER'S skill or judgment to select or furnish goods suitable for any particular purpose and that SELLER has no liability that will extend beyond the scope of the LIMITED EXPRESS WARRANTY contained herein, and BUYER hereby waives all remedies or liabilities, expressed or implied, arising by operation of law or otherwise. (including, without limitation, any obligation of SELLER with respect to fitness for any particular purpose; merchantability; and special, incidental, indirect or consequential damages) or whether or not occasioned by SELLER'S negligence.

SELLER disclaims any warranty and expressly disclaims any liability for personal injury or damages related to BUYER'S use of the PRODUCT. BUYER acknowledges and agrees that the disclaimer of any liability for personal injury is a material term for this agreement and BUYER agrees to indemnify SELLER and hold SELLER harmless from any claim related to the PRODUCT and its use or performance. Under no circumstances will SELLER be liable for any damages, liabilities, costs or expenses incurred as a result of or by reason of use, performance or sale of the PRODUCT, including without limitation, any damages, liabilities, costs or expenses incurred by reason of BUYER'S negligence related to those uses of the PRODUCT.

The proper installation of the PRODUCT is the sole responsibility of the BUYER. The SELLER assumes no liability regarding improper installation or misapplication of the PRODUCT.

## Section 15 (Continued)

## WARRANTY

SELLER hereby provides the following limited warranty as to description, quality, merchantability, fitness for the PRODUCT'S purpose, productiveness, or any other matter of SELLER'S PRODUCT sold herewith. The SELLER

shall be in no way responsible for the open use and service of the PRODUCT and the BUYER hereby waives all rights other than those expressly written herein. This Warranty shall not be extended or varied except by a written instrument signed by SELLER and BUYER.

IN THE EVENT THAT THE BUYER DOES NOT AGREE WITH THIS AGREEMENT, THE BUYER MAY PROMPTLY RETURN THE PRODUCT, IN A NEW AND UNUSED CONDITION, WITH A DATED PROOF OF PURCHASE, TO THE PLACE OF PURCHASE WITHIN THIRTY (30) DAYS FROM THE DATE OF PURCHASE FOR A FULL REFUND. THE BUYER AGREES THAT THE INSTALLATION OF THIS PRODUCT CONFIRMS THE BUYER HAS READ AND UNDERSTANDS THIS AGREEMENT AND ACCEPTS THE TERMS AND CONDITIONS OF THIS AGREEMENT.

## Warranty Procedure

In the unlikely event a warranty appears as if it may be warranted, the following steps are taken:

- 1 The customer discussed the symptoms of the problem with a PureFlow AirDog Technician. The customer is to have the system Serial Number and Model Number available for the Technician when the call is made. This will expedite all steps of the process.
- 2 The customer performs any and all tests requested by the PureFlow AirDog Technician. This is done to isolate the potential problem while eliminating potential installation or maintenance related issues,
- 3 If the PureFlow AirDog Technician determines based on the customer feedback concerning the requested testing that system may be at fault, the customer is advised that all returned pumps are tested upon arrival and should this returned pump perform at design criteria upon arrival, the customer will be charged a \$50.00 fee.
- 4 The PureFlow AirDog Technician will first request the customer's phone number in the event the phone call is accidentally disconnected and then transfer the customer to a PureFlow AirDog Customer Service Representative. Should a Customer Service Representative not be available, the Technician will offer the Customer the option to hold, call back, or receive a return call.
- 5 The PureFlow AirDog Customer Service Representative will check to determine if the customer's Warranty Registration Card is on file.
  - a. If no Warranty Registration is found, the customer will be required to supply the original purchase receipt showing the purchase date.
  - b. If no Warranty Registration is found, the customer will be advised of the options should the system in question is out of the default warranty period (1 year).
- 6 The PureFlow AirDog Customer Service Representative will request the customer information, including: Name, Address, Phone Number, Model Number, Serial Number, Year / Make / Model of vehicle, Name of Dealer purchased from, Purchase Date, Description of Problem, Customers' understanding of the resolution, and customer credit card information.
- 7 PureFlow AirDog will cover Ground Shipping charges to ship the replacement unit and will include a prepaid shipping label for the return of the defective unit. Any additional items ordered at the time of the replacement shipment will include their portion of the shipping cost.
- 8 A period of 15 Calendar Days from the time of shipment is provided for the receipt of the defective unit at the PureFlow AirDog facility. Failure to return ship the defective unit to arrive within the defined time period will result in a charge of \$250.00 against the customer's credit card as the purchase cost of the defective unit.

REVISED AUGUST 1, 2017